

Article number: 03022008

Description: Fluro Rod End GARSW 8-RR
Stainless steel complete

Measures

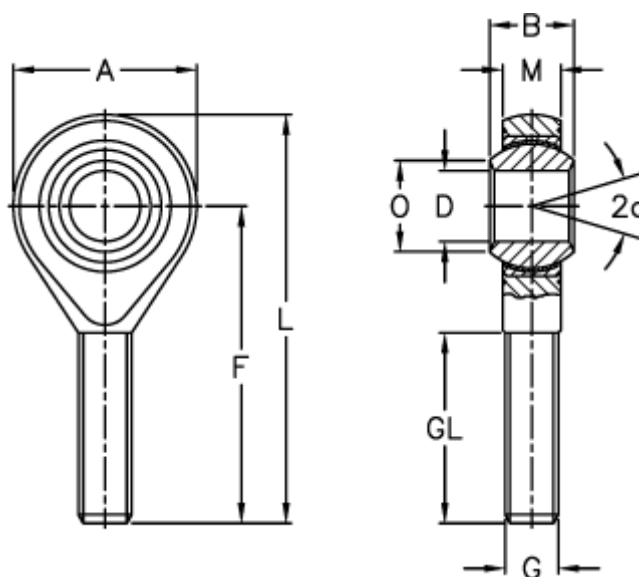

A	= 24	L	= 54
a (degrees)	= 14	M	= 9
B	= 12	O	= 10.4
D	= 8	Permissible rpm	= 420
Dynamic load C (kN)	= 16.7	Static load C0 (kN)	= 16.1
F	= 42	Weight (g)	= 33
g	= M8		
GL	= 25		